

MICROTECH MTX-8 4CYL SEQUENTIAL ENGINE MANAGEMENT SYSTEM

PINOUT TYPE #1

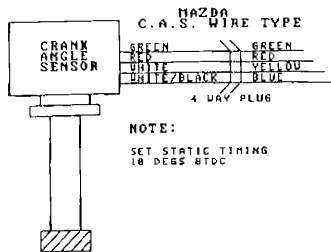

PINOUT TYPE #2

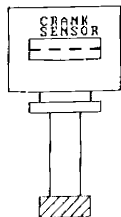
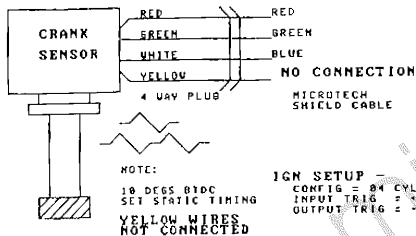

CAS PLUG VIEW

LATE MODEL

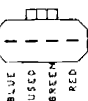

NOTE:

10 DEGS BTDC
SET STATIC TIMING
YELLOW WIRE
NOT CONNECTED

IGN SETUP -

CONFIG = 04 CYL/R
INPUT TRIG = +VE
OUTPUT TRIG = -VE

4 CYL COIL PACKS

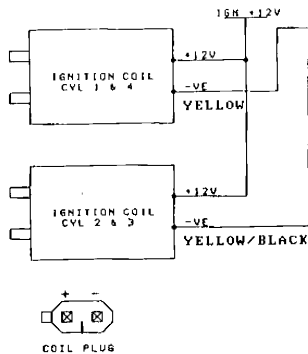

MICROTECH MTX-8 4 CYL SEQUENTIAL

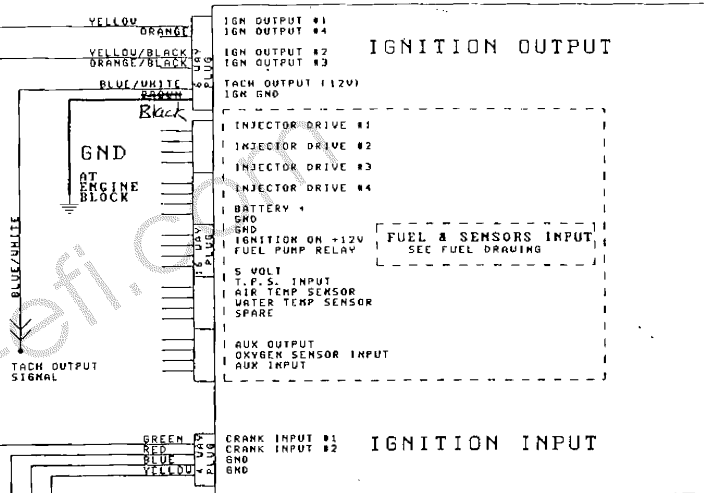

MTX-8 4 CYL PIN-OUTS

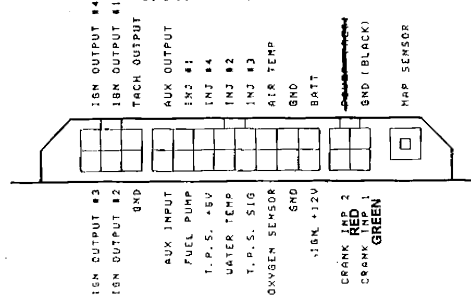

IGN SETUP -

CONFIG = 04 CYL/R
INPUT TRIG = +VE
OUTPUT TRIG = -VE
DWELL TYPE = TIME
DWELL = 2.75 MS
PUMP DWELL = 3.58 MS

MTX8 4 DIRECT FIRE		
5224	Number	Revision
03		MAGNETIC PICKUP 1.0
		IGNITION DRAWING
DATE: 27-DEC-1992	DESIGNER: J. L. 2/0/2	
DATE: 01-01-94	DRWING: J. L. 2/0/2	DRWING: J. L. 2/0/2